



www.fine-tek.com

RF-Capacitance / Admittance Level Switch



PRODUCT INTRODUCTION

PRODUCT DESCRIPTION

RF-Capacitance /Admittance level switch is appropriate for application in liquid and solid mediums. It is designed to reduce medium attaching to the probe. This product also offers DPDT output, high/low level failsafe, adjustable time delay, and sensitivity adjustment. Various models are available for high temperature, or limited space environments.

WORKING PRINCIPLE

RF-Capacitance / Admittance level switch consists of a guard section, upper insulation, main probe and grounding. The guard section is designed to overcome possible medium attachment and to secure signal accuracy. The special structure is suitable for detecting different mediums without being affected by attachments.

The upper main probe, guard, and grounding are all insulated. The level of the medium can be detected by the increasing of admittance when medium reaches the main probe.

The grounding and the main probe are insulated, thus the device will still function accurately and not cause false alarms when the medium attaches the probe.

FEATURES

- Time delay function from 0-30 seconds
- IP65 housing protection
- 5 A/250Vac output DPDT
- High/low failsafe
- Alarm testing
- Explosion Proof model available

FEATURES

- Anti-Viscosity
- Easy Installation
- Stable; not affected by temperature
- Highest temperature tolerance of 550°C
- Explosion-proof 450°C
- Applicable in liquid, syrup, solid, powder, and surface level detection

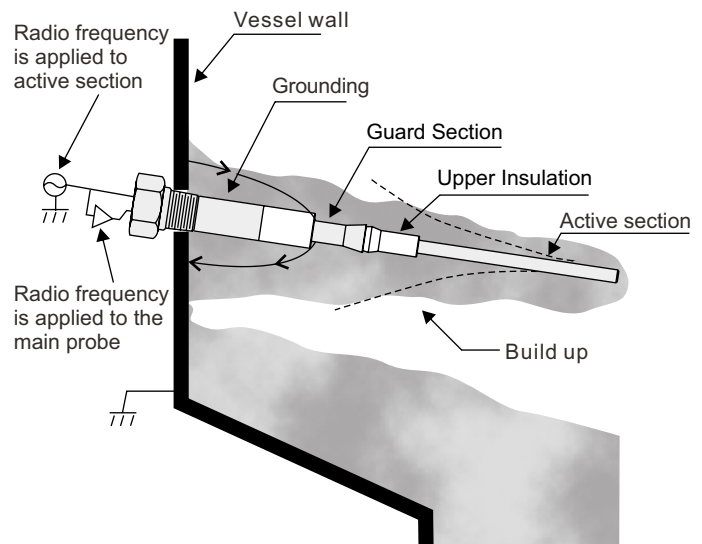

CONSTRUCTION & APPLICATION

CONSTRUCTION

1. Main probe: SUS304 or SUS316
2. Upper Insulation: The upper insulated part of the main probe and guard section have very low k dielectric constants and are made of PTFE or PEEK
3. Guard Section: The conductive metal probe helps to dissipate any possible presence of a false signal.
4. Lower Insulation: Due to the low k dielectric constant nature of the main probe, it is comprised of PTFE
5. Connection: 3/4"NPT(Standard model)
6. Housing: Aluminum alloy spray paint
7. Wiring point: 1/2" PT
8. Waterproof O-Ring: Rubber
9. Circuitry: FSH and FSL, Time delay adjustable function

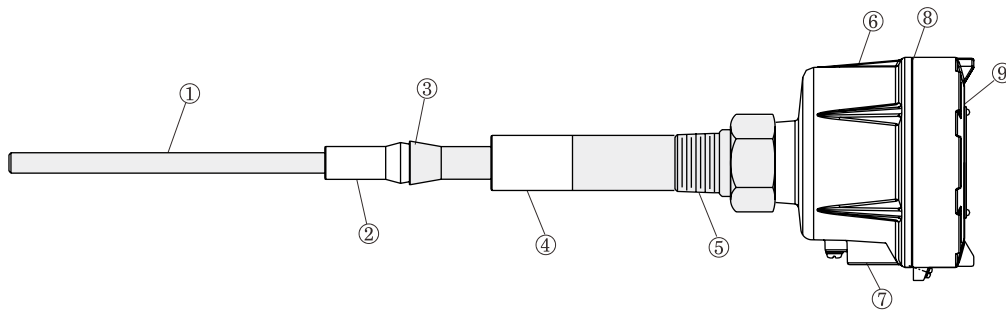

APPLICATION

Storage Tanks, Containers, Wells, Reservoirs and bins containing any liquids, powders or pellets that require precise level detection and control. Key industries include:

- Breweries
- Mining
- Paint manufacturing plant
- Coal
- Food processing
- Flour mills
- Glass Industry
- Plastics processing, polymers and synthetics
- Chemical
- Paper manufacturing
- Power plants
- Water and waste water treatment plant
- Tar
- Food and beverage

EXAMPLE

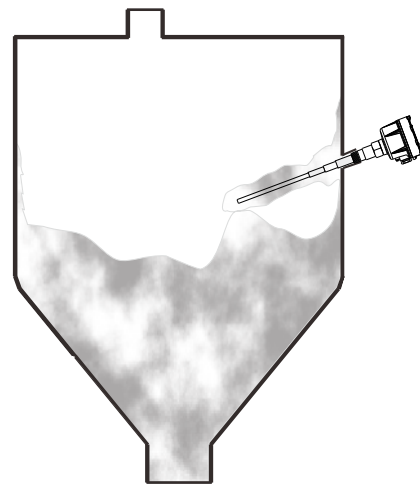

- 2100/2110: Standard model ----- Applicable to normal environments.
2200: Hi-Temperature model -----Applicable to high temperature environments.
2280: Super Hi-Temperature model -----Applicable to super high temperature environments.
2500: Cable model -----Applicable to big tank and top installation environments.
2600: Mini model -----Applicable to space constraint and small tanks.
17□□: Explosion proof type ----- Ex d IIB T6~T1

CAUTION!

When the environment is with heavy dust blowing, especially for small sized bin (diameter<Ø1m, cubic meter<1.5m³) and the dust will become thicker in the air. The change of capacitance value between dusty air and materials will become too close to influence the measurement. So we will suggest to use SCX series, tuning fork level switch or SEX series, rotary paddle level switch as better solutions for this kind of scenario.

SPECIFICATIONS

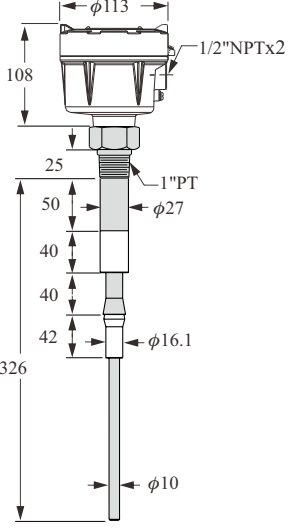
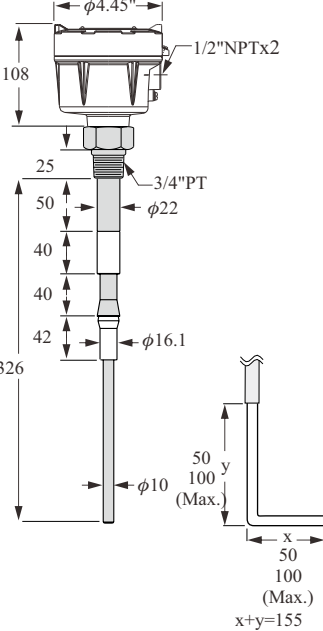
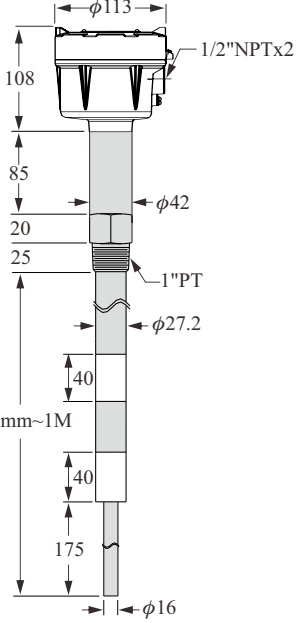
Dimension (Unit:mm)			
Order No.	SB2100 [Standard model]	SB2110 [Standard model] SB2120 [Standard L model]	SB2200 [Hi-Temperature model]
Operating temp.	-40°C~150°C	-40°C~150°C	-40°C~232°C
Ambient temp.	-40°C~70°C	-40°C~70°C	-40°C~70°C
Housing	Aluminum (IP65)	Aluminum (IP65)	Aluminum (IP65)
Probe material	SUS304 or 316	SUS304 or 316	SUS304 or 316
Insulated material	PTFE	PTFE	PEEK
Connection	1" PT	3/4" PT	1" PT
Sensitivity	0.3PF	0.3PF	0.3PF
Supply voltage	24Vdc ± 20% or 115/230Vac ± 10%, 50/60Hz	24Vdc ± 20% or 115/230Vac ± 10%, 50/60Hz	24Vdc ± 20% or 115/230Vac ± 10%, 50/60Hz
Power consumption	Max.2W	Max.2W	Max.2W
Contact rating	5A/250Vac, DPDT	5A/250Vac, DPDT	5A/250Vac, DPDT
Delay time	0~30 sec	0~30 sec	0~30 sec
Fail safe mode	High / low Fail safe mode	High / low Fail safe mode	High / low Fail safe mode
Cable entry	Two 1/2" NPT conduit entries	Two 1/2" NPT conduit entries	Two 1/2" NPT conduit entries
Operation pressure	20kg/cm ²	20kg/cm ²	20kg/cm ²

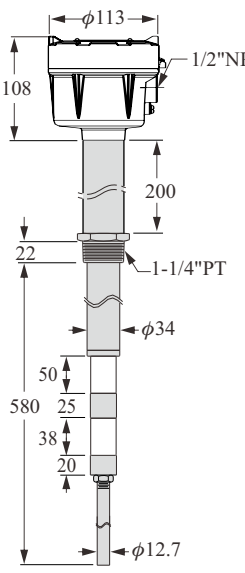
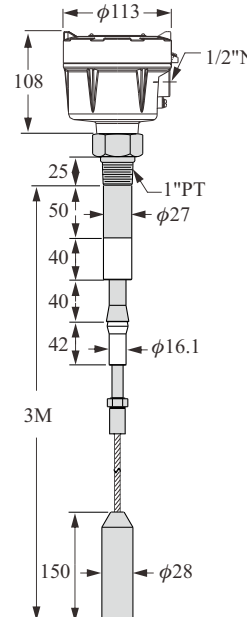
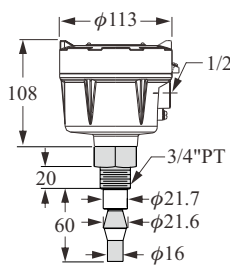
Dimension (Unit:mm)			
Order No.	SB2280 [Super Hi-Temp Model]	SB2500 [Cable Model]	SB2600 [Mini Model]
Operating temp.	-40°C~550°C	-40°C~150°C	-40°C~150°C
Ambient temp.	-40°C~70°C	-40°C~70°C	-40°C~70°C
Housing	Aluminum (IP65)	Aluminum (IP65)	Aluminum (IP65)
Probe material	SUS304 or 316	SUS304 or 316	SUS304 or 316
Insulated material	Ceramic	PTFE	PTFE
Connection	1-1/4" PT	1" PT	3/4" PT
Sensitivity	0.3PF	0.3PF	0.3PF
Supply voltage	24Vdc ± 20% or 115/230Vac ± 10%, 50/60Hz	24Vdc ± 20% or 115/230Vac ± 10%, 50/60Hz	24Vdc ± 20% or 115/230Vac ± 10%, 50/60Hz
Power Consumption	Max.2W	Max.2W	Max.2W
Contact rating	5A/250Vac, DPDT	5A/250Vac, DPDT	5A/250Vac, DPDT
Delay time	0~30 sec	0~30 sec	0~30 sec
Fail safe mode	High / low Fail safe mode	High / low Fail safe mode	High / low Fail safe mode
Cable entry	Two 1/2" NPT conduit entries	Two 1/2" NPT conduit entries	Two 1/2" NPT conduit entries
Operation pressure	ATM	20kg/cm ²	20kg/cm ²

SPECIFICATION

PTB PROOF NO. 09 ATEX 1057 $\text{Ex II 2G Ex d IIB T6-T1}$

$\text{Ex II 2D Ex tD A21 IP65 T445°C-T80°C}$

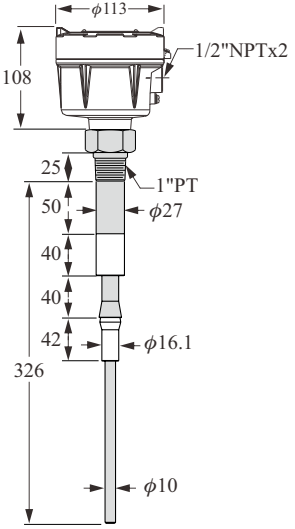
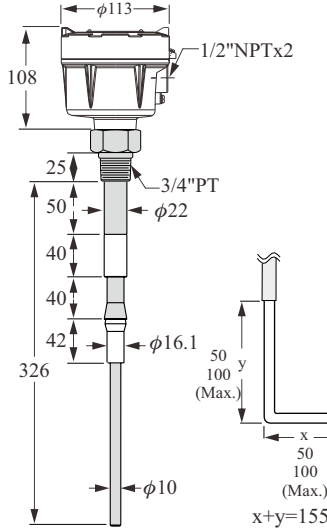
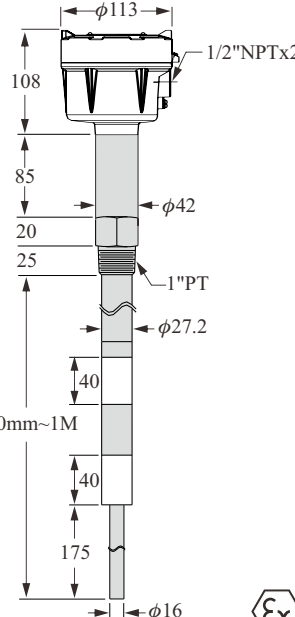
Dimension (Unit:mm)			
Order No.	SB1710 [Standard model]	SB1711 [Standard model] SB1712 [Standard L model]	SB1720 [Hi-Temp model]
Operating temp.	-40°C~150°C	-40°C~150°C	-40°C~232°C
Ambient temp.	-20°C~70°C	-20°C~70°C	-20°C~70°C
Housing	Aluminum (IP65)	Aluminum (IP65)	Aluminum (IP65)
Probe material	SUS304 or 316	SUS304 or 316	SUS304 or 316
Insulated material	PTFE	PTFE	PEEK
Connection	1" PT	3/4" PT	1" PT
Sensitivity	0.3PF	0.3PF	0.3PF
Supply voltage	24Vdc ± 20% or 115/230Vac ± 10%, 50/60Hz	24Vdc ± 20% or 115/230Vac ± 10%, 50/60Hz	24Vdc ± 20% or 115/230Vac ± 10%, 50/60Hz
Power consumption	Max.2W	Max.2W	Max.2W
Contact rating	3A/250Vac, DPDT	3A/250Vac, DPDT	3A/250Vac, DPDT
Delay time	0~30 sec	0~30 sec	0~30 sec
Fail safe mode	High / low Fail safe mode	High / low Fail safe mode	High / low Fail safe mode
Cable entry	Two 1/2" NPT conduit entries	Two 1/2" NPT conduit entries	Two 1/2" NPT conduit entries
Operation pressure	20kg/cm ²	20kg/cm ²	20kg/cm ²

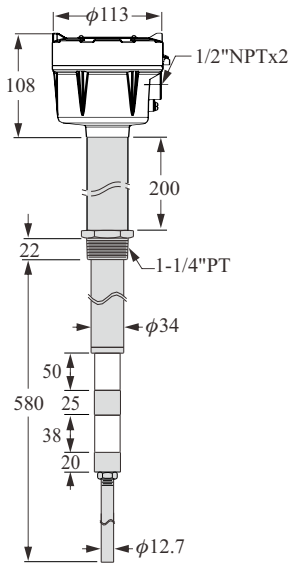
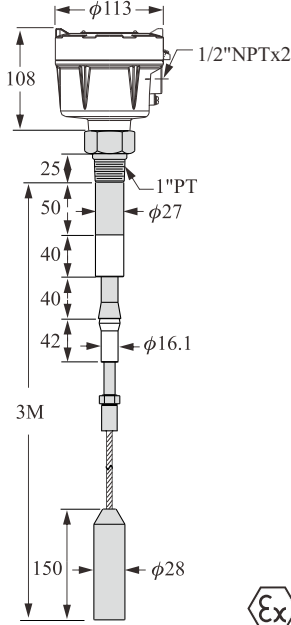
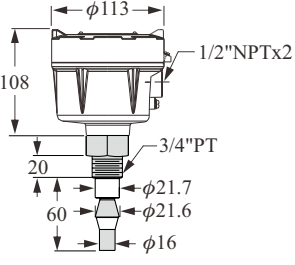
Dimension (Unit:mm)			
Order No.	SB1728 [Super Hi-Temp model]	SB1750 [Cable model]	SB1760 [Mini model]
Operating temp.	-40°C~450°C	-40°C~150°C	-40°C~150°C
Ambient temp.	-20°C~70°C	-20°C~70°C	-20°C~70°C
Housing	Aluminum (IP65)	Aluminum (IP65)	Aluminum (IP65)
Probe material	SUS304 or 316	SUS304 or 316	SUS304 or 316
Insulated material	Ceramic	PTFE	PTFE
Connection	1-1/4" PT	1" PT	3/4" PT
Sensitivity	0.3PF	0.3PF	0.3PF
Supply voltage	24Vdc ± 20% or 115/230Vac ± 10%, 50/60Hz	24Vdc ± 20% or 115/230Vac ± 10%, 50/60Hz	24Vdc ± 20% or 115/230Vac ± 10%, 50/60Hz
Power consumption	Max.2W	Max.2W	Max.2W
Contact rating	3A/250Vac, DPDT	3A/250Vac, DPDT	3A/250Vac, DPDT
Delay time	0~30 sec	0~30 sec	0~30 sec
Fail safe mode	High / low Fail safe mode	High / low Fail safe mode	High / low Fail safe mode
Cable entry	Two 1/2" NPT conduit entries	Two 1/2" NPT conduit entries	Two 1/2" NPT conduit entries
Operation pressure	ATM	20kg/cm ²	20kg/cm ²

WIRING DIAGRAMS

DESCRIPTION OF PANEL FUNCTION

- ① Set_Point: A clockwise turn(H) will result in higher admittance and lower sensitivity, while a counter-clockwise turn(L) will result in lower admittance and higher sensitivity.
- ② Red LED: When the LED is ON, it indicates power ON.
- ③ Range: For (HI) high k die-electric material, $\epsilon > 10$ / For (LO) low k die-electric material, $\epsilon < 10$.
- ④ FSH/FSL: (FSH) High level fail-safe alarm/(FSL) low level fail-safe alarm.
- ⑤ Green LED: Alarm (FSH) indicator is ON, it is empty; when it is OFF, it is loaded; Alarm (FSL) indicator is ON, it is loaded; when it is OFF, it is empty.
- ⑥ Time Delay: Set the time delay of alarm output within 0~30 seconds. Turning clockwise (L) can set to a longer time, while turning counter-clockwise (S) can set to a shorter time.
- ⑦ Analog test: Analog alarm test function, and terminal jumping switch function.
- ⑧ Relay output: Connect terminal to load, command or control.
- ⑨ Power input: Connect terminal to the power supply system.

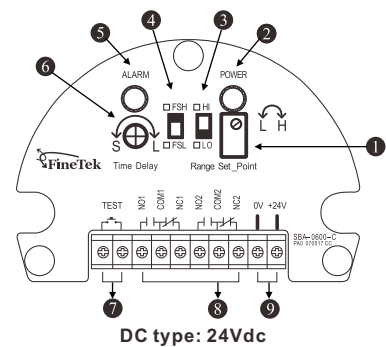
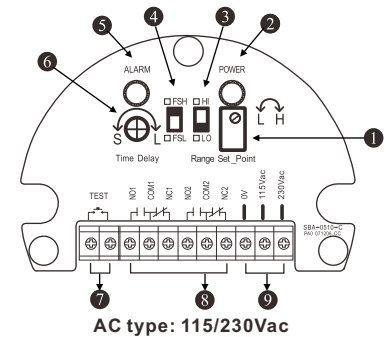

FAILSAFE ALARM

FSH high level failsafe alarm:

SB2□□□ series switch is installed at the high level point the FSH switch mode is "on". When the medium has no contact with the probe, the green LED lights up and relay output COM/NC is in an open state. When the medium level reaches high level and it touches the probe (or in the case of blackout), the green LED turns off and the relay output COM/NC is closed. When the relay output COM/NC is closed, it implies the FSH alarm has been activated.

ALARM CALIBRATION

Setting for High Level Alarm

1. Switch the FSH/FSL Knob to FSH
2. Switch the Range Knob to LO.
3. Switch the Time Delay Knob to S (Minimum).
4. Decrease the level of the medium to below the measuring probe.
5. Spin the set point knob till the Alarm LED (Green light) lights up.
6. Firstly, increases the level of the medium till it covers half of the measuring probe and the Alarm LED (green light) shut off. Secondly, spinning the Set Point Knob clockwise till Alarm LED (green light) lights up. If the Alarm LED (green light) still does not lights up after spinning it till the end, please adjust the range switch to HI and repeat procedure 5. Thirdly, record the numbers of turns and its angle, then switch the knob counterclockwise back for 1/4 twist circle and angle.
7. Adjusting the delay time for alarm (0~30 seconds): If turning the time delay knob clockwise, the delay time is postponed, while turning the Time delay knob counterclockwise, the delay time is shortened.

FSL low level failsafe alarm:

SB2□□□ series switch is installed at the low level, the FSL mode is "on". When the medium touches the probe the green LED lights up and the relay output COM/NC is in an open state. When the medium level drops below the low level and the medium does not have contact with the probe (or in the case of blackouts), the green LED turns off and relay output COM/NC is closed. When relay output COM/NC is closed, it implies the FSL alarm has been activated.

Setting for Low Level Alarm

1. Move the FSH/FSL button to FSL.
2. Move the 'range' button to LO.
3. Turn the 'time delay' knob to S (Minimum).
4. Lower the level of the medium to cover half of the measuring probe.
5. Turn the 'set point' screw counterclockwise till the Alarm LED lights up. If the LED hasn't lit up after turning it fully to the end, please adjust the 'range' button to HI and repeat procedure 5.
6. Now, decrease the level of the medium until it is below the measuring probe and the Alarm LED has turned off. Next, turn the 'set point' screw counterclockwise until the Alarm LED (green light) lights up [Recording the numbers of turns you make]. Finally, turn back the 'set point' screw clockwise for 3/4 twist circle.
7. Adjust the delay time for the alarm (0~30 seconds): When turning the 'time delay' knob clockwise, the delay time is postponed. Turning the 'time delay' knob counterclockwise, the delay time will be shortened.

MODEL NUMBER / ORDER CODE COMPARISON TABLE

Model Number	Order Code
SB2100	SBX10000-A
SB2110	SBX10000-B
SB2120	SBX10000-D
SB2200	SBX10200-A
SB2280	SBX10800-C
SB2500	SBX10000-E
SB2600	SBX10000-F

Model Number	Order Code
SB1710	SBX1001C-A
SB1711	SBX1001C-B
SB1712	SBX1001C-D
SB1720	SBX1021C-A
SB1728	SBX1081C-C
SB1750	SBX1001C-E
SB1760	SBX1001C-F

ACCESSORIES

Cable Conduit - Ex d IIC

Material: Washer — NBR

Body— Copper alloy(3/4"NPT)
Nickel plated(1/2"NPT)

HP415-A23100MH01(29-1104)

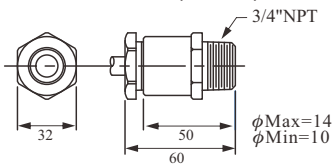

HP415-A23000MG01(29-1108)

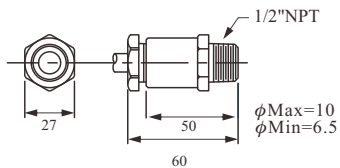

ORDER INFORMATION

SBX1 ⑤ ⑥ ⑦ ⑧ - ⑨ ⑩ ⑪ ⑫ ⑬ ⑭ ⑮ ⑯ ⑰ ⑱ ⑲ ⑳ ㉑ ㉒ ㉓ ㉔

⑤⑥ Model
 00: Standard
 02: High temperature
 08: Super high temperature

⑦⑧ Certification
 00: None
 1C: ATEX-Exd

⑨ Type
 A: $\phi 27 + 1$ "PT Standard type
 B: $\phi 22 + 3/4$ "PT Standard type
 C: High temperature type
 D: Standard L type
 E: Wire probe type
 F: Mini type

⑩ Power supply
 A: AC115V/230VAC $\pm 10\%$, 50/60 Hz(Analog alarm function)
 B: 24VDC $\pm 20\%$, 50/60 Hz(Analog alarm function)
 C: AC115/230VAC $\pm 10\%$, 50/60 Hz
 D: 24VDC $\pm 20\%$

Connection

<p>⑪⑫ Flang item AK: JIS-FF AN: ANSI-RF AS: DIN-FF</p> <p>Thread item AC: ANSI AA: JIS</p>	<p>⑬⑭ A7: 3/4" A8: 1" B1: 1-1/2" B2: 2" B4: 2-1/2" D7: DN20 D8: DN25 D9: DN32 E1: DN40 E2: DN50 E3: DN65</p>	<p>⑮⑯ 01: PT male 03: PF male 07: NPT male 40: 5 kg/cm² 42: 10 kg/cm² 48: 150 Lbs 49: 300 Lbs 57: PN10 58: PN16</p>
--	---	--

(Next page)

ORDER INFORMATION



05
06
07
08
09
10
11
12
13
14
15
16
17
18
19
20
21
22
23
24

SBX1 -

⑰⑱ Probe material

- MA: SUS 304
- MB: SUS 316
- MC: SUS 316L

⑲⑳ Insulated material

- 13: PEEK
- 21: PTFE
- 32: Ceramics

㉑㉒㉓㉔ Length

Code	Probe Length
0060~3000	0060~3000mm

Global Network

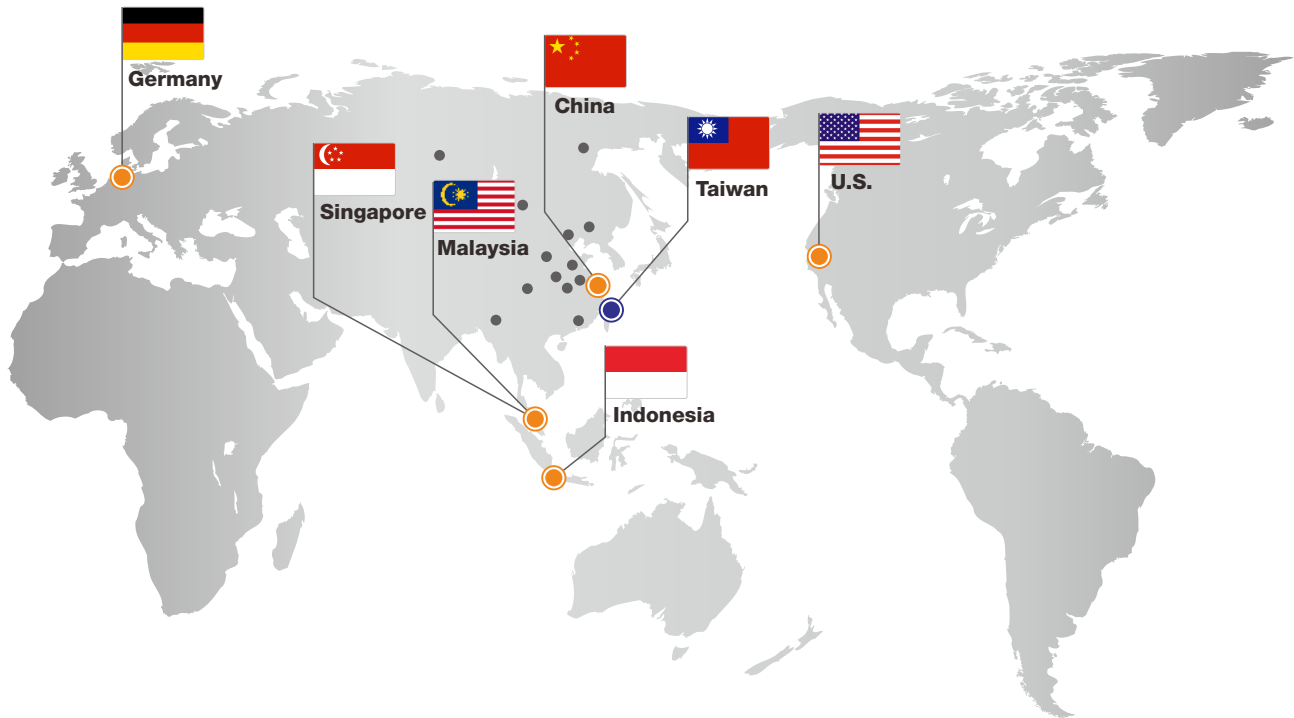

■ Head Quarte

● Taiwan

FineTek Co., Ltd. - Taipei Head Quarter 
 No.16, Tzuchiang St., Tucheng Industrial Park
 New Taipei City 236, Taiwan
 TEL: 886-2-2269-6789
 FAX: 886-2-2268-6682
 EMAIL: info@fine-tek.com

■ North America

● California, U.S.

Aplus Finetek Sensor Inc. - US Office
 355 S. Lemon Ave, Suite D, Walnut,
 CA 91789
 TEL: 1 909 598 2488
 FAX: 1 909 598 3188
 EMAIL: info@aplusfine.com

■ Europe

● Germany

FineTek GmbH - Germany Office
 Bei den Kämpen 26
 21220 Seevetal-Ramelsloh, Germany
 TEL: +49-(0)4185-8083-12
 FAX: +49-(0)4185-8083-80
 EMAIL: info@fine-tek.de

■ Asia

● China

Fine automation Co., Ltd. - Shanghai Factory 
 No.451 DuHui Rd, MinHang District, Shanghai,
 China 201109
 TEL: 86-21-6490-7260
 EMAIL: info.sh@fine-tek.com

● Singapore

FineTek Pte Ltd. - Singapore Office
 37 Kaki Bukit Place, Level 4 Singapore 416215
 TEL: 65-6452-6340
 EMAIL: info.sg@fine-tek.com

● Indonesia

PT. FineTek Automation Indonesia - Indonesia Office 
 Tunas Bitung Industrial Park Blok C3 No.12 dan No.15
 Jalan Raya Serang Km.13.8 Kabupaten Tangerang 15710 Banten
 TEL: 62 (021)-2958-1688
 EMAIL: info.id@fine-tek.com

● Malaysia

FineTek Co., Ltd. - Malaysia Office
 8-05, Plaza Azalea, Persiaran Bandaraya,
 Seksyen 14, 40000 Shah Alam, Selangor, Malaysia
 TEL: 603-5524-7168
 EMAIL: info.my@fine-tek.com

● Müttec Instruments GmbH - Germany Office

Bei den Kämpen 26
 21220 Seevetal-Ramelsloh, Germany
 TEL: +49-(0)4185-8083-0
 FAX: +49-(0)4185-8083-80
 EMAIL: muetec@muetec.de



Distributor: