

The easy access to
non-contact temperature
measurement:
Smart, safe and fast
from -50 to 1030 °C

Features:

- Temperature range: -50 °C to 1030 °C
- Response time: 14 ms
- Optical Resolution: 15:1
- Green LED alarm indication, aiming support, selfdiagnostic or temperature code indication
- Usable up to 80 °C ambient temperature without cooling
- Several outputs selectable: 0–10 V or 0–5 V free scalable or thermocouple type K, alarm output or digital output
- Easy adjustment via IRmobile Android App and Windows software (CompactConnect)
- Power supply: 5–30 V DC

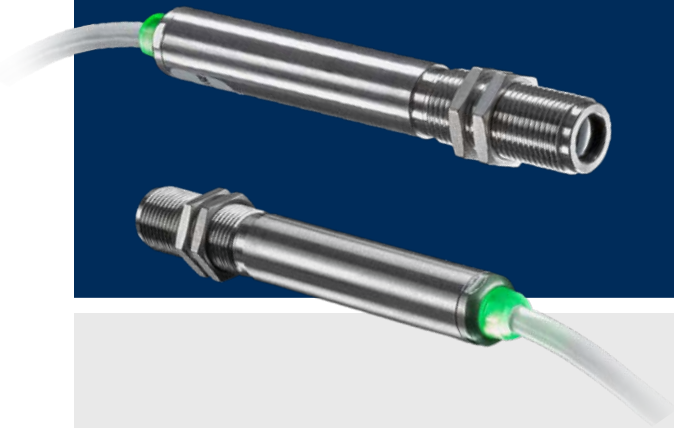

General Specifications

Environmental rating	IP 65
Ambient temperature	-20 °C ... 80 °C
Storage temperature	-40 °C ... 85 °C
Relative humidity	10–95 %, non condensing
Vibration	IEC 60068-2-6 (sinus shaped) IEC 60068-2-64 (broadband noise)
Shock	IEC 60068-2-27 (25G and 50G)
Weight	58 g

Electrical Specifications

Output / analog	Selectable: 0–5 V or 0–10 V free scalable or thermocouple type K/ alarm with adjustable voltage levels
Output / alarm	0–30 V/ 50 mA (open collector)
3-state alarm output	Adjustable threshold values and voltage level for: no alarm, pre-alarm, alarm
Output / digital	Uni/ bidirectional, 9.6 / 115.2 kBaud (adjustable via software), 0/3 V digital level/ USB optional
Input (0–10 V)	Programmable functional input for external emissivity setting/ambient temperature adjustment, triggered signal output or peak-hold function
LED-functions	Alarm indication, automatic aiming support, self diagnostic, temperature indication (via. temp.code)
Cable length	1 m (standard), 3 m, 8 m, 15 m
Power supply	5–30 V DC
Current draw	4 mA (without LED) / 10 mA

Measurement Specifications

Temperature range (scalable via software)	-50 °C ... 1030 °C
Spectral range	8 - 14 μm
Optical resolution (90 % energy)	15:1
CF-lens (optional)	0.8 mm @ 10 mm
System accuracy (at ambient temp. 23 ±5 °C)	±1.5 % or ±1.5 °C ¹⁾
Repeatability (at ambient temp. 23 ±5 °C)	±0.75 % or ±0.75 °C ¹⁾
Temperature coefficient	±0.05 K/K or ±0.05 % / K ²⁾
NETD	50 mK ³⁾
Response time (90 %)	14 ms (adjustable up to 999 s)
Emissivity/Gain (adjustable via 0–10 V DC input or software)	0.100–1.100
Transmissivity (adjustable via software)	0.100–1.100
Signal processing (parameter adjustable via software)	Peak hold, valley hold, average; extended hold function with threshold and hysteresis
Software / App	optris CompactConnect / IRmobile

¹⁾ Object temperature > 0 °C ; whichever is greater

²⁾ For ambient temperatures <18°C and >28°C; whichever is greater

³⁾ At time constant 200 ms and T_{Obj} 200°C

optris CS LT

Optical Specifications

Optics, D:S = 15:1

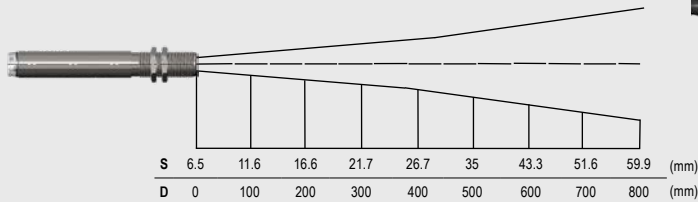

Optics with CF-lens, D:S = 15:1

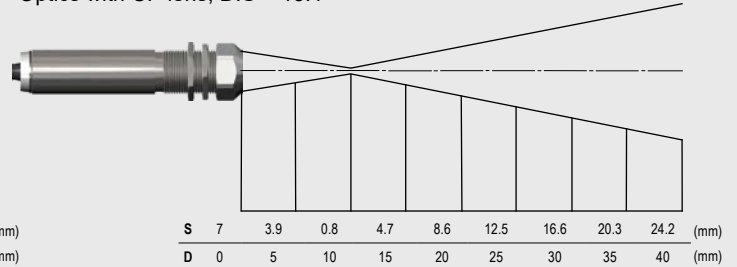

Connections

Connection analog with open collector alarm output (e.g. to actuate a relay)

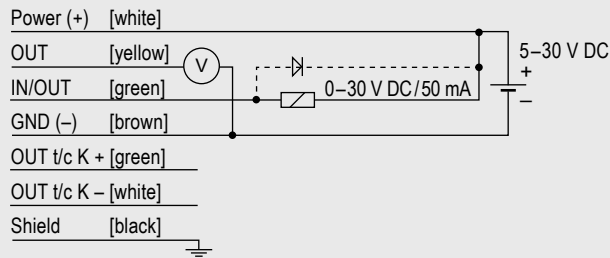

Connection digital with the optional IR app connector

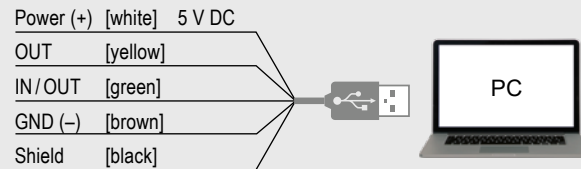

The CS LT can be connected to a smartphone via the IR app connector.



Dimensions / Accessories (examples)

Dimensions optris CS

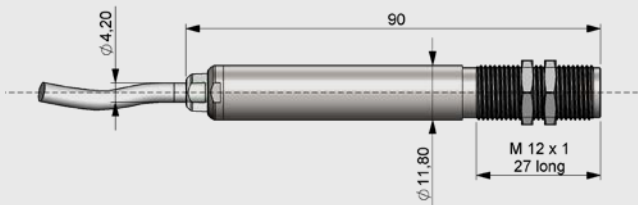

CF-lens (ACCTCF)

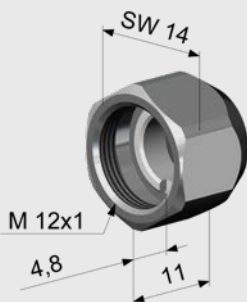

Mounting bracket, fixed (ACCTFB)

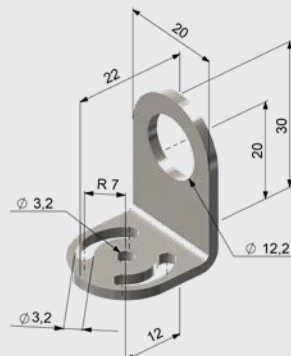

Air purge collar, optional with integrated CF-lens (ACCTAPLCF)

